

# ISDN S Interface Transformer

Turns Ratio ( ± 2% )	1CT : 1CT
----------------------	-----------

## SCHEMATIC DIAGRAM

PARAMETER	MIN.	MAX.	UNITS
Open Circuit Inductance	22		mHy
Leakage Inductance		5	μHy
Interwinding Capacitance ( $C_{w/w}$ )		100	pF
Distributed Capacitance ( $C_d$ )		40	pF
Primary DC Resistance	2.04	2.76	ohms
Secondary DC Resistance	2.04	2.76	ohms
Isolation (HI-POT)	2.0K		V <sub>RMS</sub>
<b>TEST CONDITIONS:</b> Oscillation Voltage = 700mV Oscillation Frequency = 10.0 KHz Inductance measured on Primary winding. Pins 1 - 3.			

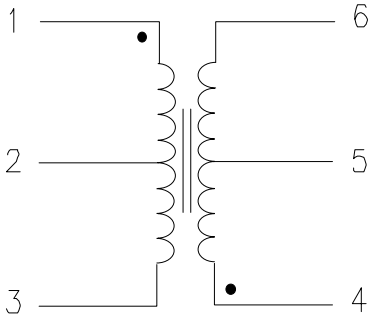

MEETS THE PULSE WAVEFORM  
TEMPLATE OF CCITT I.430.

Primary is Line Side

Unbalanced current at TE:  $\Delta I_{dc} = 1 \text{ mA max.}$

Longitudinal Conversion Loss - 10KHz to 300  
KHz: 60dB min.

Flammability: Materials used in the  
production of these units are UL94-VO  
and meet requirements of IEC 695-2-2  
needle flame test.

Unused Pins Omitted

## PHYSICAL DIMENSIONS inches (mm)

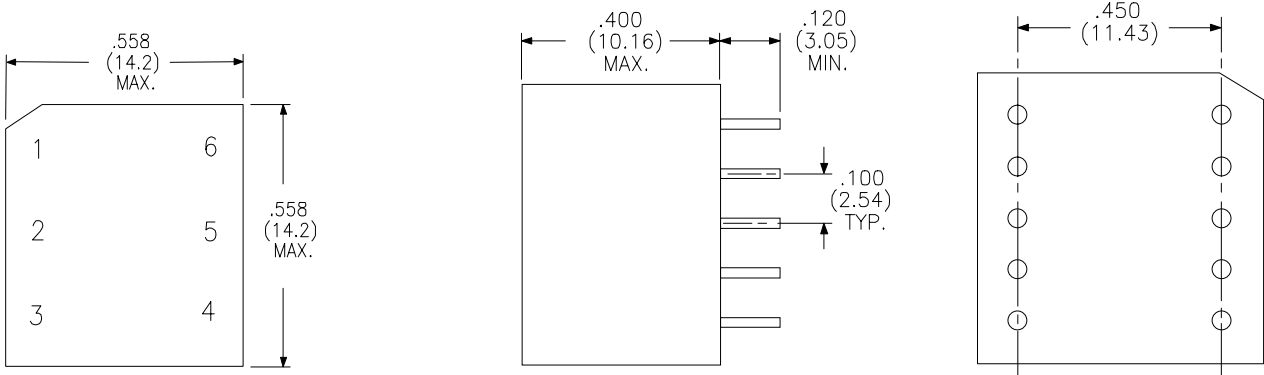

RHOMBUS P/N: T-10400	
CUST P/N:	NAME:
DATE: 6/22/95	SHEET: 1 OF 1